

> PRIVA BLUE ID S-LINE UI4/UI8/UI16

Universal input module



A Priva Blue ID S-Line UI4/UI8/UI16 provides software configurable inputs for analogue and digital use. Three variants of the module can be supplied: with 4, 8 and 16 inputs.

Characteristics

- measures voltage, current and resistance
- types of measurement in digital mode: status measurement and pulse counter
- automatic measurement range set point in resistance mode
- hum suppression in analogue mode
- high resolution
- inputs electrically isolated from system neutral
- each wire has its own terminal block
- field power (FP) loop through
- field ground (FG) loop through
- hot swappable
- 24 V system power supply monitoring
- LED per input, colour is adjustable
- LED for status of module
- Priva Blue ID Lifeline
- text card for identification of inputs

Areas of application

The inputs on the module can be programmed for analogue or digital use. This makes the module very flexible. Even measurement type is setup in software. Setting the resistance measurement manually is also not needed.

Modular solution

An optimal fit is always possible because the module is available with a choice of 4, 8 or 16 inputs.

Modular design

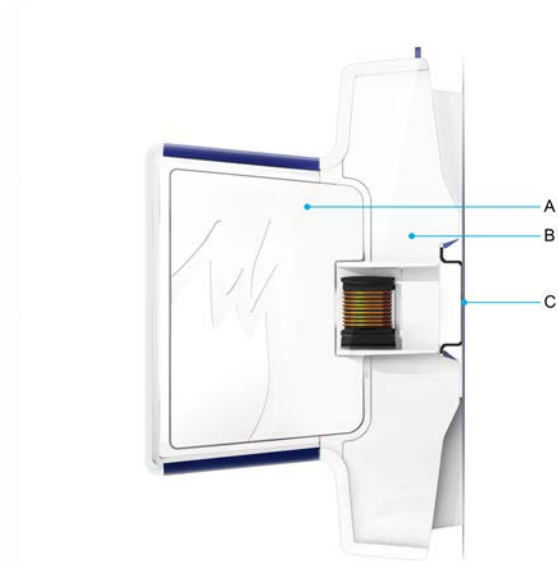

Module (A) and base (B) form a unique combination. As a result of this, a module cannot be incorrectly positioned in a base.

You simply click the base onto the DIN rail (C). The wiring easily connects to the base via spring terminals. The base remains in place when replacing the module, removing the need to rewire.

Hot swappable

Removing a module from the base and replacing it can easily be done without tools. This can be done live (hot swappable).

Wiring

You do not need to disconnect wiring when exchanging modules. This is because the wiring is connected to the module's base.

Quick and faultless wiring

Each input has four terminals. In addition to a terminal for the device, each input has an FG terminal and an FP terminal that can be used to wire a sensor directly to the module. This avoids looping the wiring through. Apart from these connections, a Ref terminal is available for ratiometric voltage measurement.

Clear indication

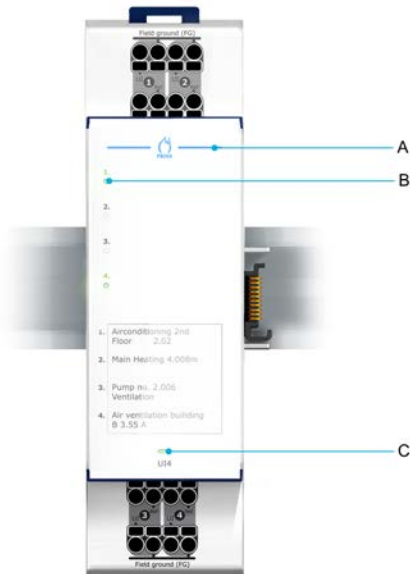

Legend

A	Priva Blue ID Lifeline
B	LEDs for status of inputs for digital use
C	LED for status of module

Priva Blue ID Lifeline

The modules are equipped with blue LEDs. Together, these LEDs form the Priva Blue ID Lifeline. If the blue line is continuously on, the modules and bases are in the correct place according to the configuration in TC Engineer.

LEDs for status of inputs

For each input, an LED indicates the status of the input. Depending on the configuration, the LED is green, red or off. The LED only works when the input is being used digitally.

LED for status of module

The LED shows the status of the module. The LED is on continuously when the module is working correctly. If not, the LED flashes or the LED is off.

LED details

Details about statuses and indications of modules, input and/or outputs and the related LED colours and flashing patterns, are described in the *LEDs and Priva Blue ID Lifeline* appendix of the *Installing and commissioning* manual.

Connections

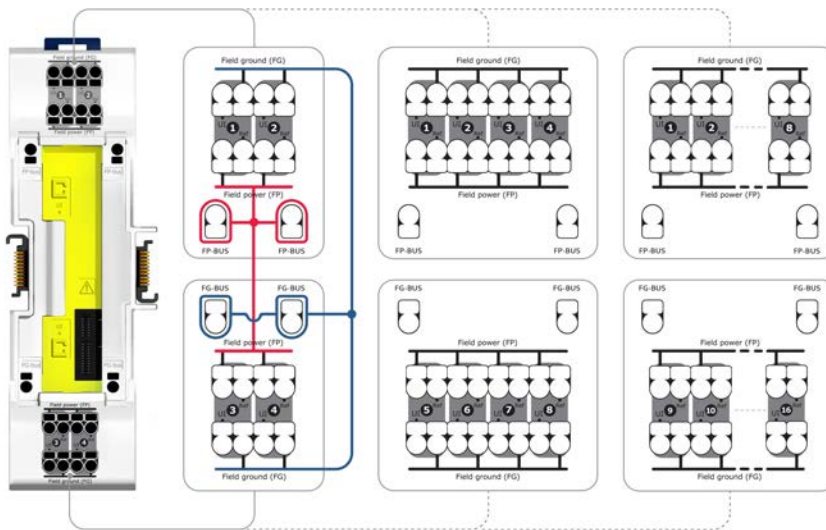

Legend

UI	universal input
Ref (Reference voltage)	5V voltage for reading of three-wire potentiometers
Field power (FP)	power supply for active sensors
Field ground (FG)	neutral for input and power supply

UI module specifications

General			
Module article description	Priva Blue ID S-Line UI4 Universal input module	Priva Blue ID S-Line UI8 Universal input module	Priva Blue ID S-Line UI16 Universal input module
Module article number	5073001 (V03:01 and higher)	5073002 (V03:01 and higher)	5073003 (V04:01 and higher)
Base article description	Priva Blue ID S-Line UI4 Universal input base	Priva Blue ID S-Line UI8 Universal input base	Priva Blue ID S-Line UI16 Universal input base
Base article number	5073101 (V02:00 and higher)	5073102 (V02:00 and higher)	5073103 (V02:00 and higher)
Number of universal inputs	4	8	16
Dimensions (XYZ) ¹	161.5 x 46 x 100.2 mm (6.36 x 1.81 x 3.94 inches)	161.5 x 61 x 100.2 mm (6.36 x 2.40 x 3.94 inches)	161.5 x 92.2 x 100.2 mm (6.36 x 3.63 x 3.94 inches)
Weight	module: 140 grams base: 140 grams	module: 220 grams base: 160 grams	module: 240 grams base: 280 grams
Maximum power consumption	3.1 W	4.8 W	7.4 W
Typical power dissipation ²	2.7 W	4.0 W	6.0 W
MTBF ³	module: 790,000 hours base: 8,760,000 hours	module: 790,000 hours base: 8,760,000 hours	module: 540,000 hours base: 8,760,000 hours
Construction	removable module on a base		
Mounting of base	clicks onto DIN rail		
Material	mixture of polycarbonate and ABS		
Connector type for power supply and I/O	terminal block		
Permitted core cross section area	solid: 0.2 ... 4 mm ² flexible: ... 2.5 mm ² flexible with ferrule connector: 0.25 ... 1.5 mm ²		
Identification of connections	abbreviated labelling		

¹ Excluding 1.1 mm room between the modules

² Dissipation under the following conditions:
- I/O load of 50%
- Energy saving mode on (LEDs off)

³ The MTBF is calculated according to the *Telcordia SR-332 standard Issue 2* under the following conditions:
- ambient temperature: 35 ... 50 °C
- supply voltage: 24 VDC
- time in operation per day: 24 hours
- reliability level: 60 %



Universal analogue inputs used

Type of measurement to be set per input	voltage ratiometric voltage (potentiometer) current resistance
Mains frequency suppression (NMRR @ 50/60 Hz)	-60 dB (applies for a pure sinus)

Voltage measurement

Measurement range	0 ... 10 V
Maximum permitted input voltage	26,4 VAC -24 ... 30 VDC
Number of measurements per second	50 @ 50 Hz mains frequency 60 @ 60 Hz mains frequency
Resolution	14 bits over 12 V (730 μ V)
Accuracy	\pm (5mV + 0,1 % of the measurement)
Input resistance	> 1 M Ω
Maximum source resistance	1 k Ω

Ratiometric voltage measurement (potentiometer)	
Measurement range	0 ... VRef (0 ... 100 %)
Maximum permissible input voltage	26.4 VAC -24 ... 30 VDC
Number of measurements per second	50 @ 50 Hz mains frequency 60 @ 60 Hz mains frequency
Resolution	± 0.015 % (approximately 13 bits over 100 %)
Accuracy	± (0.05 % + 0.05 % of the measurement)
Input resistance	> 1 MΩ
Out of range determination (a measurement outside of this range results in alarm message)	U _{in} < -1 V U _{in} > +11 V
Reference voltage VRef	+5 V nominal
Maximum load per VRef	5 mA (1 kΩ)
Maximum potentiometer value	4 kΩ (maximum source resistance 1 kΩ)
Protection VRef	26.4 VAC -24 ... 30 VDC continuous -26.4 ... 30 VDC for a maximum of 3 minutes

Current measurement	
Input current measurement range	0 ... 22 mA
Maximum permissible input voltage	26.4 VAC 0 ... 30 VDC
Maximum permissible capacitor capacitance between UI and FP (24 VDC) ¹	200 μF
Number of measurements per second	50 @ 50 Hz mains frequency 60 @ 60 Hz mains frequency
Resolution	2.3 μA (approximately 13 bits over 20 mA)
Accuracy	± (40 μA + 0.4 % of measurement)
Input resistance	250 Ω, nominal
Protection	resistor for current measurement is switched off automatically in the event of overvoltage (self-restoring after 5 minutes)

¹ A higher capacity may activate the input overvoltage protection. In this event, install an external 5.6 V Zener diode between UI (cathode) and FG (anode).

Resistance measurement				
Measuring range (automatic selection)	0 ... 2.5 kΩ	0 ... 10 kΩ	0 ... 40 kΩ	0 - 200 kΩ
Accuracy (nominal, at an ambient temperature of 50 °C)	± (0.8 Ω + 0.22 % of the measurement)	± (1.0 Ω + 0.4 % of the measurement)	± (2.3 Ω + 0.41 % of the measurement)	± (41 Ω + 1.12 % of the measurement)
Maximum permissible input voltage	26.4 VAC -24 ... 30 VDC			
Number of measurements per second	1 @ 50 Hz mains frequency 1.2 @ 60 Hz mains frequency			
Resolution	AVM and RM: approximately 14 bits RVM and CM: approximately 13 bits			
Maximum permitted capacity at input	10 nF			

Universal inputs for digital use	Alternating current	Direct current
Voltage range	0 ... 26.4 VAC	0 ... 30 VDC
Maximum permitted input voltage range	0 ... 26.4 VAC	-24 ... 30 VDC
Type of measurements	status and pulse	status and pulse
Minimum detectable pulse width (Live contact)	500 ms (Mechanical and electronic switch)	35 ms (Mechanical and electronicswitch)
Minimum detectable pulse width (Dry / open collector)	-	1000 ms (Mechanical and electronicswitch)
Maximum input frequency (Live contact, 50% duty cycle)	-	14 Hz (Mechanical and electronicswitch)
Maximum input voltage "0"	3 VAC	3 VDC
Minimum input voltage "1"	12 VAC	12 VDC
Minimum detectable switching voltage on input	12 VAC at aforementioned threshold voltages	-
Range of configurable threshold voltage (using software)	0 ... 30 VAC	-
Current from input with pull-up resistor enabled	-4 mA nominal	-





Others	
Input voltage between FP bus and FG bus	0 ... 30 VAC 0 ... 30 VDC
Field power supply	double isolation between input and output
Functional isolation of inputs in relation to system neutral	240 VDC 240 VAC
Maximum load current field power supply per module	750 mA
FP protection	protected against short circuits/overload with internal common fuse for all inputs
Maximum FP bus and FG bus current	FP bus in - FP bus out: 10 A FG bus in - FG bus out: 10 A
Signalling	<ul style="list-style-type: none"> • Priva Blue ID Lifeline • green-red LEDs for status of inputs for digital use (colour is adjustable) • green LED for status of module

General specifications of controllers, modules and bases

Housing	
IP code	IP30 (IEC 60529)
Flammability class	V-0 (UL 94)
Recycle code	7
Colour	release surfaces of module and DIN rail release: blue (RAL5013) other parts: white (RAL9003)
Device type	open device, for use in a pollution degree 2 environment

Installation and connection	
Installation	<p>in control panel:</p> <ul style="list-style-type: none"> • accessible to authorized personnel only • can be clicked onto the DIN rail that is positioned horizontally or vertically on the mounting plate <p>Note: The controller, SC module and SN module may only be mounted horizontally.</p> <p>in panel door integration in control panel:</p> <ul style="list-style-type: none"> • accessible to authorized personnel only • can be clicked onto the DIN rail that is positioned horizontally on the mounting plate
DIN-rail type	35 x 7.5 mm (height x depth), in accordance with IEC 60715
Maximum width of I/O modules, bus extension modules and controller	20 mm

Environment	
Permitted temperature inside control cabinet during normal operation with horizontally mounted modules only (without airflow)	0 ... 50 °C
Permitted temperature inside control cabinet during normal operation with vertically mounted modules only (without airflow)	0 ... 35 °C
Permitted temperature during transport and storage	-20 ... 70 °C
Permitted relative ambient humidity	10 % ... 95 % (non-condensing)
Shock and vibration resistance	IEC 61131-2
Installation category	II

Legislation and standards	
Canada / USA	 <ul style="list-style-type: none"> • UL 508:2005 (industrial control equipment) • UL 916:2007 (energy management equipment) • UL 61010-1:2004 (measurement and control equipment) • CSA C22.2 No 14-10: 2011 (industrial control equipment) • CSA C22.2 No 205-12: 2012 (signal equipment) • CSA C22.2 No 61010-1-04 (measurement and control equipment)
	EMC <ul style="list-style-type: none"> • complies with 47 CFR Part 15 Subpart B, Class B (FCC Rules) Operation is subject to the following two conditions: <ol style="list-style-type: none"> 1. This system may not cause harmful interference. 2. This system must accept any interference received, including interference that may cause undesired operation. • ISM-system, complies with Canadian ICES-001
Europe	 <ul style="list-style-type: none"> • Low voltage directive 2006/95/CE: <ul style="list-style-type: none"> • EN 61010-1:2010 (measurement and control equipment) • EMC directive 2004/108/EC: <ul style="list-style-type: none"> • EN 61326-1:2006 (measurement and control equipment) • EN 61000-6-2:2005 (generic immunity standard) • EN 61000-6-3:2007 (generic emission standard) • RoHS directive 2011/65/EU
	 <p>complies with the WEEE directive 2002/96/EC</p>
International	 <ul style="list-style-type: none"> • The Priva Blue ID S-Line S10 Controller is BTL registered at BACnet International. • The Priva Blue ID S-Line S10 Controller is BACnet certified in accordance with ISO 16484-5/6. • Priva is a member of the BACnet Interest Group Europe.

Priva (head office)
Zijlweg 3
2678 LC De Lier
The Netherlands

Your Priva partner:

See www.priva.com for contact information of a Priva office or partner for your region.

