

> PRIVA BLUE ID C-LINE UI8 Universal input module



A Priva Blue ID C-Line UI8 Universal input module provides software configurable inputs for analogue and digital use.

Characteristics

- 8 software configurable inputs for analogue and digital use
- measures voltage, current and resistance
- types of measurement in digital mode: status measurement and pulse counter
- automatic measurement range set point in resistance mode
- noise suppression in analogue mode
- high resolution
- inputs electrically isolated from system neutral
- 24 V system power monitoring
- line-up LED
- LED for status of I/O

Areas of application

The inputs on the module can be programmed for analogue or digital use. This makes the module very flexible. Even measurement type is setup in software. Setting the resistance measurement manually is also not needed.

Internal bus

The system is equipped with an internal bus which is implemented to the outside as an I/O bus. The 24 VDC system power, for instance, is distributed via this bus. The communication between controller and modules also runs via the I/O bus.

Easy installation

You simply click the module onto the DIN rail. The wiring connects to the module via spring terminals or screw connectors (optional).

The module can also be installed in a DIN 43870 distribution box.

Components

All functions and indications are on the front of the module.

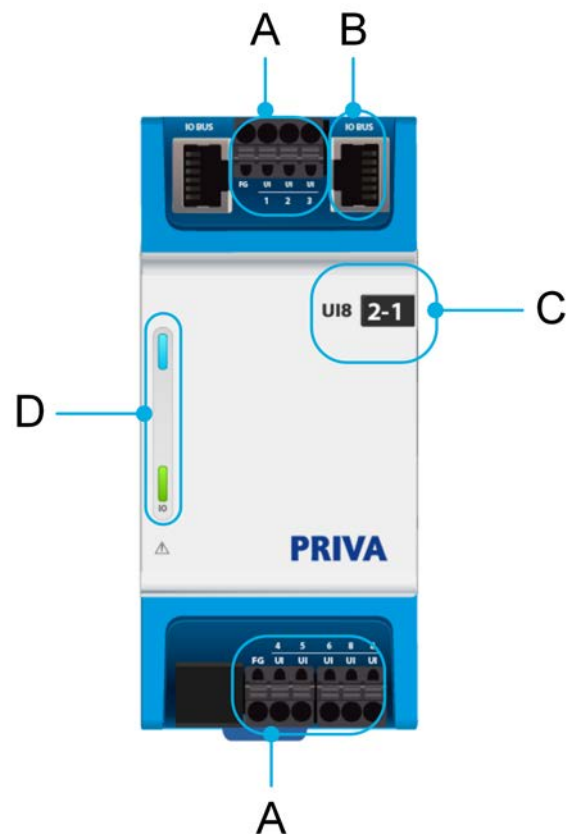

Legend

Front

A	connections for: <ul style="list-style-type: none"> • universal inputs • field ground (common)
---	--

B	I/O bus
C	module information: <ul style="list-style-type: none"> • module name • number of the module in the line-up
D	general module LEDs

Clear indication

The module has general LEDs that indicate the status of the module.

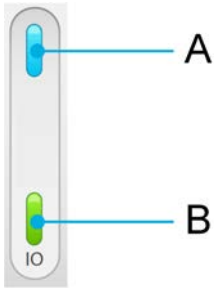

Legend

A	line-up LED
B	LED for status of the I/O

Line-up LED

The module is equipped with a blue line-up LED. If the blue LED is continuously on, the module is in the correct place according to the set configuration.

LED for I/O status

The green LED shows the status of the I/O on the module. If the I/O on the module is working correctly, the LED will be green and on continuously. If the I/O on the module is not working correctly or has another (non-operational) status, the LED will flash green.

Connections - universal input



UI	universal input
FG (Field ground)	common neutral for input

Specifications of Priva Blue ID C-Line UI8 Universal input module

General	
Module article description	Priva Blue ID C-Line UI8 Universal input module
Module article number	5213001
Dimensions (XYZ)	140 x 63 x 62 mm (5.6 x 2.5 x 2.5 inches)
Width according to DIN 43880	3.5 TE (HP) (1 TE = 18 mm (0.71 inches))
Mounting depth for DIN 43870 distribution box ¹	53.5 mm (2.11 inches)
Weight	0.16 kg (0.35 lb)
Maximum power consumption	24 VDC: 1.5 W
Typical power dissipation ²	1.8 W
MTBF ³	2,190,000 hours
Installation	clicks onto DIN rail can be mounted in DIN 43870 distribution box
Housing material	mixture of polycarbonate and ABS
Button material	TPE (synthetic rubber)
Number of universal inputs	8
Accuracy of internal temperature measurements	+/- 2°C (35.6 °F)

¹ measured between the front of the DIN rail and the rear of the cover plate.

² Dissipation under the following conditions:

- I/O load of 50%
- 50% of the LEDs on

³ The MTBF is calculated according to the *Telcordia SR-332 standard Issue 3* under the following conditions:

- ambient temperature: 35 ... 50°C (95 ... 122 °F)
- supply voltage: 24 VDC
- time in operation per day: 24 hours
- reliability level: 60%

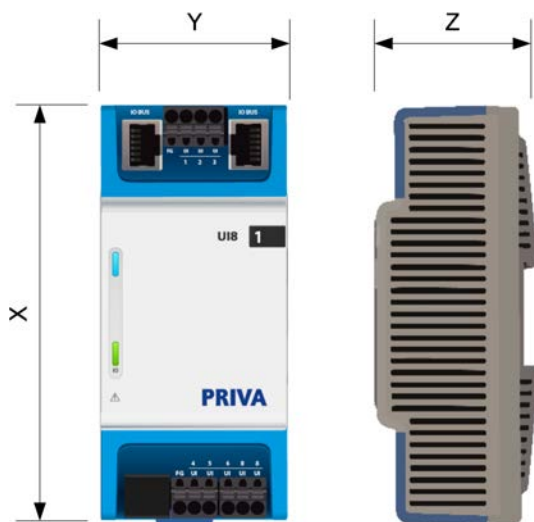

Universal inputs - Analogue use

Type of measurement to be set per input	voltage current resistance
Mains frequency suppression (NMRR @ 50/60 Hz)	-60 dB (applies for a pure sinus)

Universal input - Voltage measurement

Measurement range	0 ... 10 V
Maximum permissible input voltage	26.4 VAC -24 ... 30 VDC
Number of measurements per second	50 @ 50 Hz mains frequency 60 @ 60 Hz mains frequency
Resolution	14 bits over 12 V (730 μ V)
Accuracy	\pm (5mV + 0.1% of the measurement)
Input resistance	> 1 M Ω
Maximum source resistance	1 k Ω

Universal input - Current measurement

Input current measurement range	0 ... 22 mA
Maximum permissible input voltage	26.4 VAC 0 ... 30 VDC
Number of measurements per second	50 @ 50 Hz mains frequency 60 @ 60 Hz mains frequency
Resolution	2.3 μ A (approximately 13 bits over 20 mA)
Accuracy	\pm (40 μ A + 0.4% of measurement)
Input resistance	250 Ω , nominal
Protection	resistor for current measurement is switched off automatically in the event of overvoltage (self-restoring after 5 minutes)

Universal input - Measurement of resistance				
Measuring range (automatic selection)	0 ... 2.5 kΩ	0 ... 10 kΩ	0 ... 40 kΩ	0 - 200 kΩ
Accuracy (nominal, at an ambient temperature of 50 °C (122 °F))	± (0.8 Ω + 0.22% of the measurement)	± (1.0 Ω + 0.4% of the measurement)	± (2.3 Ω + 0.41% of the measurement)	± (41 Ω + 1.12% of the measurement)
Maximum permissible input voltage	26.4 VAC -24 ... 30 VDC			
Number of measurements per second	1 @ 50 Hz mains frequency 1.2 @ 60 Hz mains frequency			
Resolution	approximately 14 bits			
Maximum permitted capacity at input	10 nF			

Universal inputs - Digital use	Alternating current	Direct current
Voltage range	0 ... 26.4 VAC	0 ... 30 VDC
Maximum permitted input voltage range	0 ... 26.4 VAC	-24 ... 30 VDC
Type of measurements	status and pulse	status and pulse
Minimum detectable pulse width (Live contact)	500 ms (Mechanical and electronic switch)	35 ms (Mechanical and electronic switch)
Minimum detectable pulse width (Dry / open collector)	-	1000 ms (Mechanical and electronic switch)
Maximum input frequency (Live contact, 50% duty cycle)	-	14 Hz (Mechanical and electronic switch)
Maximum input voltage "0"	3 VAC	3 VDC
Minimum input voltage "1"	12 VAC	12 VDC
Current from input with pull-up circuit enabled	-	-4 mA nominal

Universal input - Other	
Functional isolation of inputs in relation to system neutral	250 V
Maximum current of FG connections	10 A
Indication (for modules with manual override or indication only)	<ul style="list-style-type: none"> green/red LEDs for status of inputs for digital use (colour is adjustable)



General specifications of Priva Blue ID C-Line controllers and modules

System power supply	Requirements
The system power supply for the controllers and Mix I/O modules must meet the following requirements.	
Output voltage	24 VAC ± 25%; 50/60 Hz ± 5 % 24 VDC ± 10%
Insulation	double insulation between input and output
Type of power supply	for UL916, CSA C22.2 No. 205: UL listed / CSA certified Class 2 extra low output voltage power supply

Housing	
IP code	IP20 (IEC 60529)
Flammability class	V-0 (UL 94)
Recycle code	7
Colour	housing: white (RAL9001) and blue (NCS S 1560-R90B) connections and connectors: black (RAL9011)
Type of device	open type equipment for: <ul style="list-style-type: none"> indoor use only pollution degree 2 environment

Installation and connection	
Installation	in control panel: <ul style="list-style-type: none"> • accessible to authorised personnel only • can be clicked onto horizontally or vertically positioned DIN rail. DIN rail installed directly on a mounting plate or floating with respect to the mounting plate in DIN 43870 distribution box
Type of DIN rail	35 x 7.5 (1.38 x 0.30 inches) or 35 x 15 mm (1.38 x 0.59 inches) (height x depth), in accordance with IEC 60715
Connector type for power supply and I/O	pluggable terminal block screw connectors (optional)
Permitted core cross section area	solid: 0.2 ... 2.5 mm ² (25 ... 14 AWG) flexible with ferrule connector: 0.2 ... 2.5 mm ² (25 ... 14 AWG) flexible with double ferrule connector: 0.2 ... 1.5 mm ² (25 ... 16 AWG)
Strip length/connector length (terminal block)	solid: 10 mm (0.39 inches) flexible with ferrule connector: 10 mm (0.39 inches) flexible with double ferrule connector: 12 mm (0.47 inches)
Strip length/connector length (screw connector)	8 mm (0.31 inches)
Identification of connections	labelling with an explanatory abbreviation
Maximum length of I/O bus cable between modules	3 m (9.84 ft)
Maximum length of I/O bus (total, including modules)	20 m (65.62 ft)

Environment	
Permitted temperature inside control panel of a working system (without air flow)	0 ... 50 °C (32 ... 122 °F)
Permitted temperature during transport and storage	-20 ... 70 °C (-4 ... 158 °F)
Maximum height	3000 m (9842 ft)
Permitted ambient relative humidity	10%...95% (non-condensing)
Shock resistance	EN 60068-2-27 (Ea)
Vibration resistance	EN 60068-2-27 (Fc)
Installation category	II
Other installation and environmental requirements	do not expose to direct sunlight

Legislation and standards		
Canada / USA		<ul style="list-style-type: none"> • UL 916 (energy management equipment) • UL 61010-1 (measurement and control equipment) • UL 61010-2-201 (measurement and control equipment) • CSA C22.2 No 61010-1-12 (measurement and control equipment) • CSA C22.2 No 61010-2-201-14 (measurement and control equipment) • CSA C22.2 No 61010-1-04 (measurement and control equipment) • CSA C22.2 No 205-12 (signal equipment)
	EMC	<ul style="list-style-type: none"> • in compliance with 47 CFR Part 15 Subpart B, Class B (FCC Rules) Functioning must meet two conditions: <ol style="list-style-type: none"> 1. The system must not cause harmful interference. 2. The system must acknowledge all interference received, including interference that may cause unwanted operations. • ISM system, in accordance with Canadian standard ICES-001
Europe		<ul style="list-style-type: none"> • Low Voltage Directive 2006/95/EC: <ul style="list-style-type: none"> • EN 61010-1 (measurement and control equipment) • EN 61010-2-201 (measurement and control equipment) • EMC Directive 2004/108/EC: <ul style="list-style-type: none"> • EN 61326-1 (measurement and control equipment) • EN 61000-6-2 (generic immunity standard) • EN 61000-6-3 (generic emission standard) • RoHS directive 2011/65/EU
		in compliance with WEEE directive 2012/19/EU
International	IEC	<ul style="list-style-type: none"> • IEC 61010-1 (measurement and control equipment) • IEC 61010-2-201 (measurement and control equipment)

Legislation and standards

International		<ul style="list-style-type: none">• The Priva Blue ID C4 C-MX34 Controller and Priva Blue ID C4 C-MX34m Controller with manual override are BTL-registered with BACnet International.• The Priva Blue ID C4 C-MX34 Controller and Priva Blue ID C4 C-MX34m Controller with manual override are BACnet-certified in accordance with ISO 16484-5/6.• Priva is a member of the BACnet Interest Group Europe.
---------------	---	---

Priva (head office)
Zijlweg 3
2678 LC De Lier
The Netherlands

Your Priva partner:

See www.priva.com for contact information of a Priva office or partner for your region.

